

# Installation Manual

## DIRECTV Multi-Satellite Dish Antenna with Integrated Triple LNB and Built-in Multi-Sw

www.DreamSatellite.com

### Introduction

Your DIRECTV Multi-Satellite Dish antenna is designed for use with up to four independently operating DIRECTV Receivers. Along with your receiver User Manual, this guide will provide the information you'll need to successfully install and operate your DIRECTV System. Throughout the manual, the DIRECTV Multi-Satellite Dish antenna will be referred to as the "antenna."

For best results, we suggest you read carefully through these pages first before beginning installation. The guide is intended for an individual experienced in performing the various tasks described, including:

- Determining an antenna location with a good southerly view of the satellites
- Climbing a ladder and working on your roof
- Observing safe working practices around heights and electrical hazards
- Determining if there are water pipes, gas lines or wiring hidden near where you may drill
- Using a power drill to drill holes into your house
- Routing coaxial cable(s) through foundation, wall, under-floor, attic or interior walls
- Safely lifting and securing the 20-lb. antenna assembly
- Grounding the antenna and cable(s) as recommended in the National Electric Code (NEC)\*

NOTE: If you don't feel completely comfortable with these tasks, simply contact the store where you purchased the system for information on having your system installed by a local authorized DIRECTV installer.

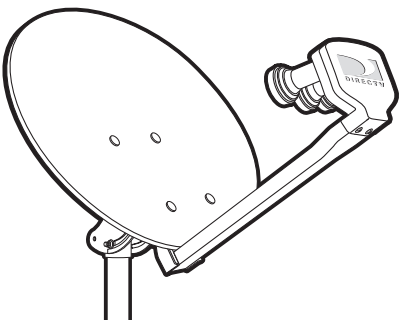

### Safety Information

Local building and electrical codes (NEC) require the antenna and the coaxial cables to be connected to a grounding electrode. Improper installation may seriously damage the equipment or the building, as well as cause injury or death to you. For your own safety, follow these important safety rules or contact a licensed inspector or electrician in your area for assistance:

- If you will be mounting your antenna in a location where it will be difficult or dangerous to view the attached bubble level (see page 6), use a small mirror or plumbing level instead. DO NOT risk falling
- Perform as many functions as possible on the ground
- Do not install the antenna on a rainy, snowy or windy day
- Make sure there are no people, pets, etc. below when you are working on the roof
- Watch out for power lines which may be overhead, underground and/or hidden behind walls, keeping safely clear of them with ladders, antenna and tools during installation

The Federal Communications Commission (FCC) has ruled that a local government or homeowner's association may not prevent the installation of satellite antennas one meter or smaller in diameter, unless legitimate safety restrictions such as fire codes are in effect. Call FCC tel: (202) 418-0163; FCC Web sites at <http://www.fcc.gov/cgb/satellite.html> or <http://www.fcc.gov/mb/facts/otard.html> for more information.

ACTIVATION OF PROGRAMMING MAY BE SUBJECT TO CREDIT APPROVAL AND REQUIRES VALID SERVICE ADDRESS, SOCIAL SECURITY NUMBER AND/OR MAJOR CREDIT CARD. DEPOSIT OR PREPAYMENT MAY BE REQUIRED. Programming subject to change. You must be physically located in the U.S. to be an authorized DIRECTV customer. DIRECTV services not provided outside the U.S. DIRECTV programming is sold separately and independently of DIRECTV System hardware. A valid programming subscription is required to operate DIRECTV System hardware. Activate your DIRECTV programming today at 1-800-DIRECTV (1-800-347-3288).

\*NEC is published by the National Fire Protection Association, 1 Batterymarch Park, Quincy, Massachusetts, 02269-9101 and may be available at your local public library.

# Antenna Assembly Overview

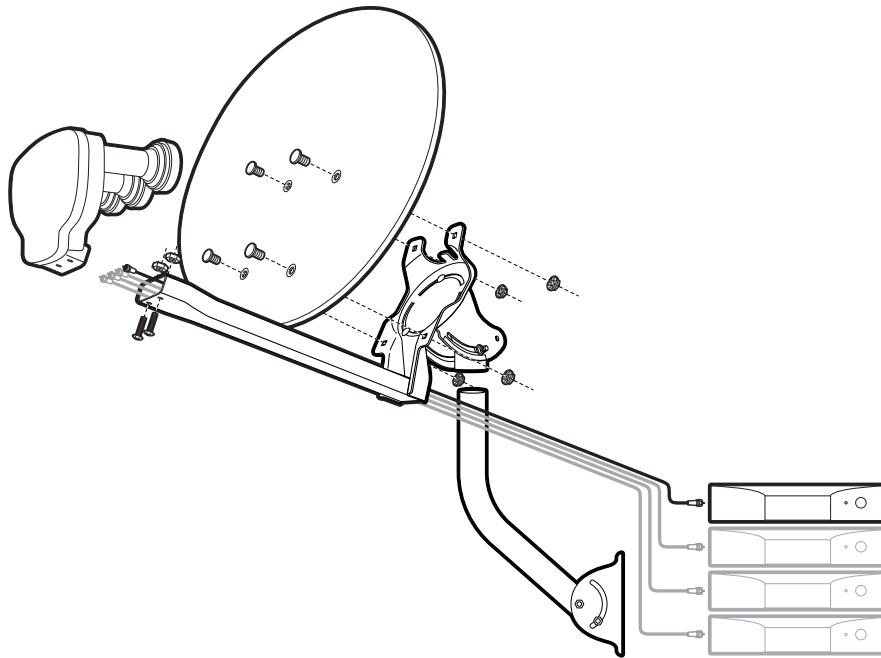

## Contents of Package

Dish Mounting Hardware



Multi-Satellite Dish Reflector

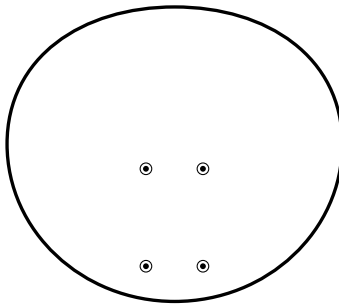

LNB Arm/Antenna Back Assembly

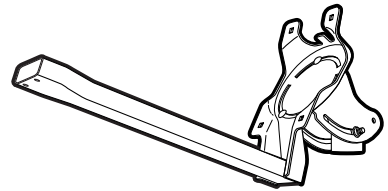

Triple-head, Multi-Satellite LNB with built-in Multi-Switch for four Independent Outputs

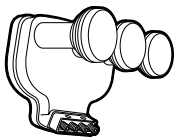

LNB Mounting Hardware



Grounding Screw



EZALIGN™ Mast

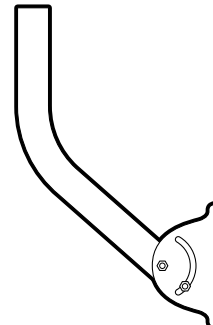

## Tools Required

---

7/16" Nut Driver



Adjustable Wrench



Screwdriver (Phillips)



Magnetic Compass

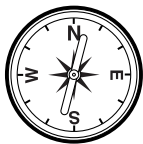

Electric Drill and Bit

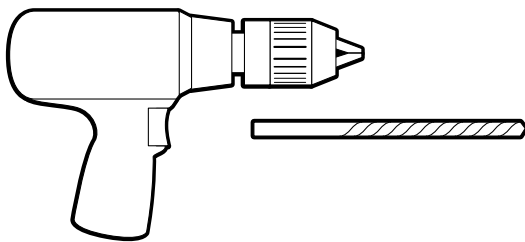

## Steps for Installation

---

In the following pages, you'll find step-by-step instructions for:

- 1 Determining Coordinates for Aiming Antenna ..... page 4
- 2 Finding Suitable Antenna Site ..... page 5
- 3 Installing EZALIGN™ Mast ..... page 6
- 4 Assembling/Adjusting Antenna on Ground ..... page 7
- 5 Attaching Antenna to Mast ..... page 7
- 6 Routing RG 6 Cable(s) ..... page 8
- 7 Grounding Cable and Antenna ..... page 8
- 8 Attaching LNB to Antenna ..... page 9
- 9 Aiming and Fine-tuning Antenna ..... page 9

### Information Also Included:

- Troubleshooting Check List for Initial Installation ..... page 11
- Loss of Signal/Rain Fade ..... page 12
- Installation with Long Cable Run ..... page 12

## Optional Accessories (not included)

---

Typical installation kits (sold separately) include:

- Mast base mounting hardware
- RG 6 coaxial cable(s) with F connectors
- Grounding hardware, grounding wire, wire clips, etc.
- 6" plumbing level

**STEP 1**

# Determining Coordinates for Aiming Antenna

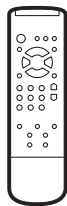
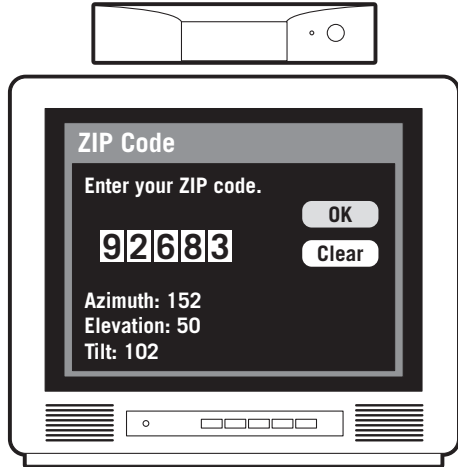

Depending on your receiver model, your display may look different from shown. In this example, a Southern California ZIP code "92683" is entered and receiver outputs:

- Azimuth: 152
- Elevation: 50
- Tilt: 102

The coordinates (Azimuth, Elevation and Tilt numbers) are based on your ZIP code and can be determined easily by using your receiver. You will need these numbers for site survey and antenna adjustments.

**NOTE:** The antenna does not need to be installed for this step.

### Connect your receiver to the TV

Consulting your receiver manual, connect the receiver's video or Channel 3/4 outputs to the corresponding TV input. Turn on the TV and the receiver.

### Set the antenna type

Navigate to the antenna installation screen menu. Select installation as an "oval 3-sat" (some receiver brands may call it: "triple", "3 sat location", "Sat 1,2,3" or "Sat A,B,C").

### Find your coordinates

Navigate to the antenna-pointing menu screen. Enter your ZIP code, then write down the numbers in space provided below.

Azimuth  
(horizontal, side-side)

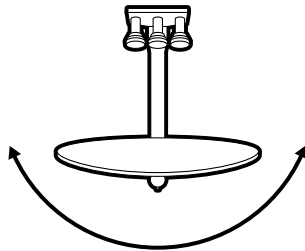

\_\_\_\_\_

Your Azimuth

Elevation  
(vertical, up/down)

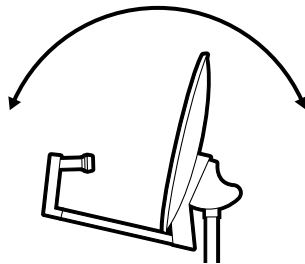

\_\_\_\_\_

Your Elevation

Tilt  
(dish reflector rotation)

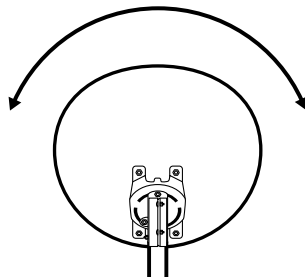

\_\_\_\_\_

Your Tilt

STEP 2

# Finding Suitable Antenna Site

If you live on the West Coast, the satellites will be to the south-southeast.

If you live on the East Coast, the satellites will be to the southwest.

A suitable antenna site requires an unobstructed view of the southern sky, a stable antenna mounting surface, a distance of 100-ft or less for RG 6 cable from your antenna to your receiver, and grounding nearby.

**NOTE:** It's important to estimate the cable length at this point.

The DIRECTV satellites are located in the southern sky above the Equator. The location for your antenna must have elevation-angle clearance (above the horizon) and 18° span clearance (from 101° to 119°) for an unobstructed view to all three satellite locations. Northern border states have elevation readings toward 30° and southern border states toward 60°.

**NOTE:** If you are replacing an 18" dish with a new Multi-Satellite Dish Antenna, be sure to check for the required 18° clearance. If you do not have the required clearance, you should use a different location.

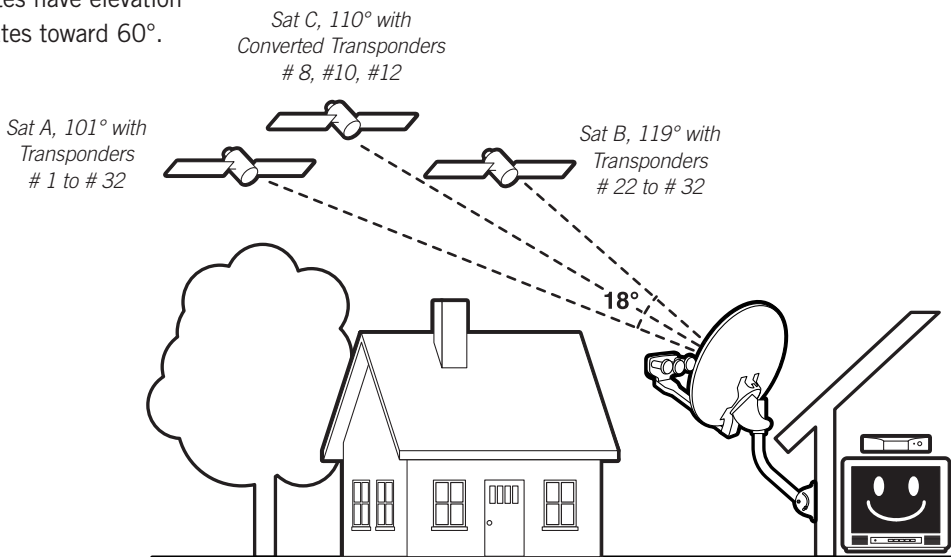
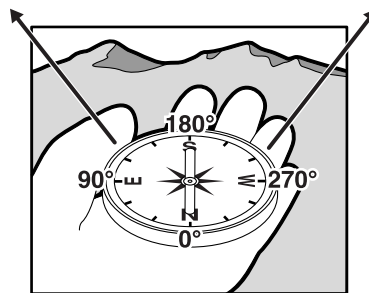

No trees, leaves, buildings can be in the line-of-sight between antenna and satellites.

Due to the many configurations possible, mast-mounting hardware is not included. Be sure you have the necessary mounting hardware before you begin. Optional mounting kits are available at your local electronics store. Below are potential mounting sites.

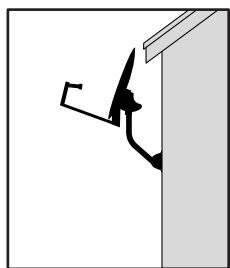

Stucco Exterior Wall

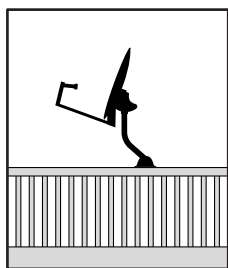

Wooden Rail

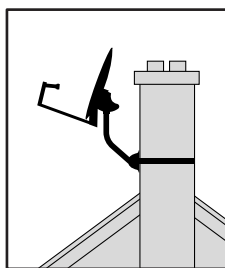

Chimney

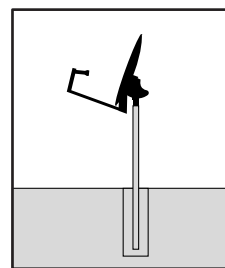

Ground

View of bubble level on top of mast

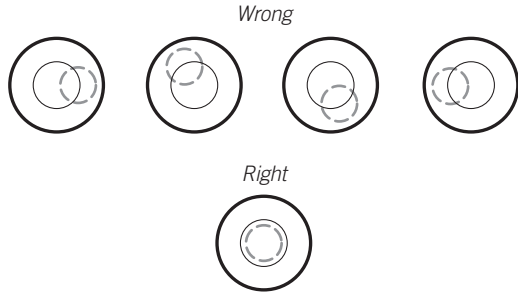

Side view of bubble level in the mast

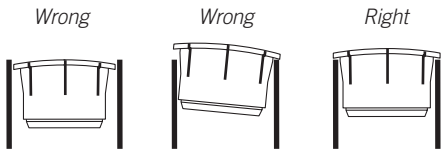

Make sure the bubble level frame in the mast is seated properly by pressing down flat on it so the lip of the frame sits snugly on the top edge of the mast.

Looking down into mast

The patented mast has two slots at the the bottom that allow it to move up and down and side to side. This aids the centering the bubble level even when the mast base is mounted on an uneven surface.

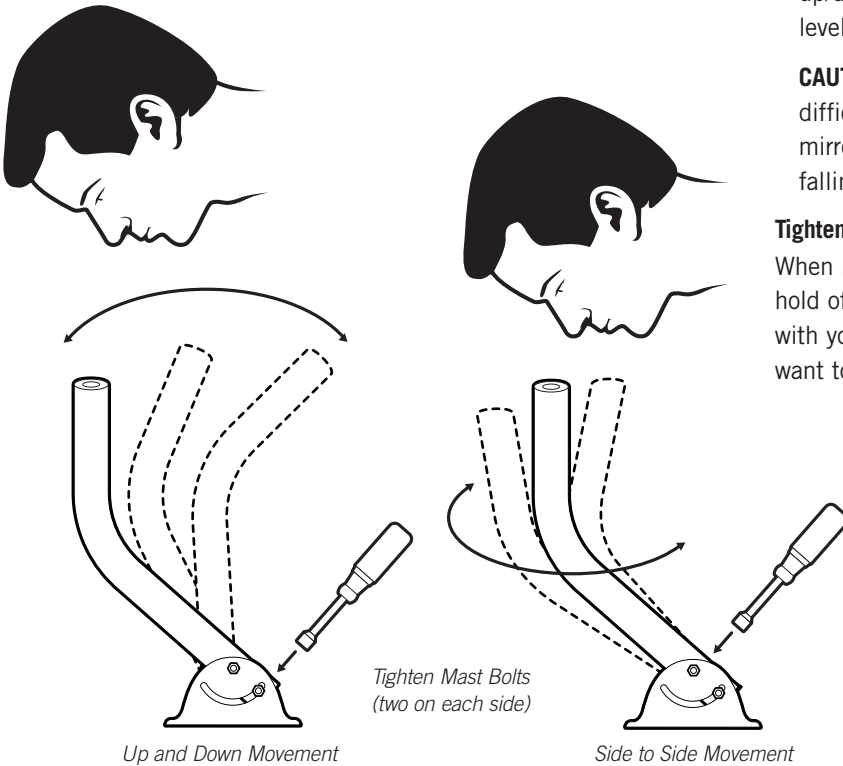

### STEP 3 Installing EZALIGN™ Mast

Now, you're ready to install the antenna mast at the location you've chosen in Step 2 and align it to be plumb (perfectly straight up). *Plumbing the mast is critical* for the Multi-Satellite Dish antenna to receive optimal signals, and failure to align it properly will result in difficulty acquiring signals as well as a greater tendency for signal outages in adverse weather.

#### Mount the base securely

The mast base must be sturdy so antenna does not shift under various weather conditions and its own weight. Mounting is preferable on wood or masonry. Unsuitable sites may be handrail, aluminum or vinyl siding, composite paneling, and fiber/particle/strand boards.

**CAUTION!** When installing mast base, avoid placing finger between mast bottom and base to prevent being pinched or cut.

#### Align the mast

- The EZALIGN Mast pivots up and down, and from side to side. A bubble level is located in the top of the mast to assist in alignment.
- Loosen the four mast bolts slightly. Then move the mast up/down or twist side-to-side until the bubble in the bubble level is centered as shown at left.

**CAUTION!** If the mast is mounted in a location where it is difficult or dangerous to view the bubble level, use a small mirror or plumbing level instead. DO NOT reach out and risk falling from roof or other high place.

#### Tighten mast bolts

When mast is straight up (plumbed), and while still keeping hold of the mast, tighten the four bolts with a 7/16" nut driver with your other hand. Make sure bolts are secure. You may want to tighten further with an adjustable wrench.

**STEP 4**

## Assembling/Adjusting Antenna on Ground

Dish attaching to the LNB Arm/Antenna Back Assembly

On even ground, attach dish to the LNB Arm/Antenna Back Assembly as shown. Leave off the Triple-head LNB until the antenna is mounted on the mast and you've routed cable through the LNB Arm.

### Set Tilt Adjustment

- At the back of the antenna assembly, loosen the Tilt nuts and then set the Tilt adjustment according to the coordinate number you obtained in Step 1.
- Tighten the Tilt nuts. *Do not change the Tilt adjustment again* from this point on (even if you could not find the satellite signal during alignment). Unlike the Elevation and Azimuth coordinates, there is no need to fine-tune Tilt; doing so may cause alignment difficulty. For some of the Eastern Seaboard states, however, there maybe an exception: see Step 9, note #2, on page 10.

### Set Elevation Adjustment

- At the side of the antenna assembly, loosen the two Elevation nuts (one on each side) and preliminarily set the Elevation adjustment, per the coordinate number obtained in Step 1.
- Tighten the Elevation nuts, but not completely. This is a preliminary adjustment, which you may have to fine-tune later on.

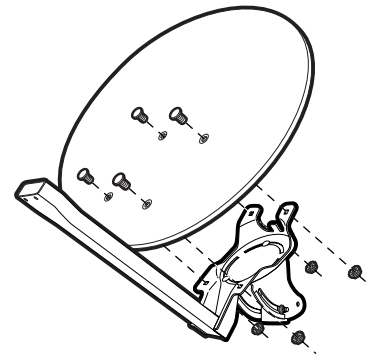

In this example we have for Southern California (ZIP code 92683), the Tilt setting is 102°.

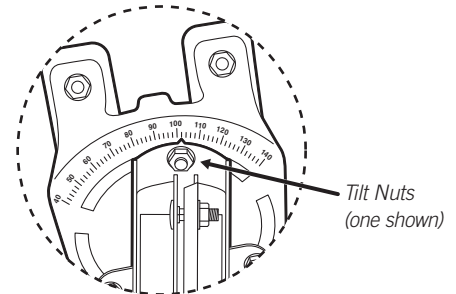

In this example we show for Southern California (ZIP code 92683), the Elevation setting is 50° (use the position of the metal edge to the Elevation scale; do not use the washer or the bolt as reference).

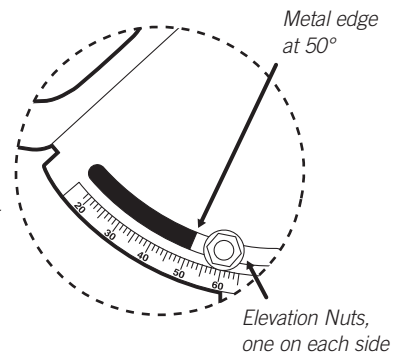
**STEP 5**

## Attaching Antenna to Mast

- Slide the back of the antenna assembly onto the top of the mast until it stops at the pivot bolt. If necessary, slightly loosen the two Azimuth/Mast clamp bolts and pivot bolt so the antenna will go on to the mast.
- Tighten the two Azimuth/Mast clamp bolts and the pivot bolt just enough so the antenna has only side-to-side movement (rotational swing around the mast) for later Azimuth alignment in Step 9.

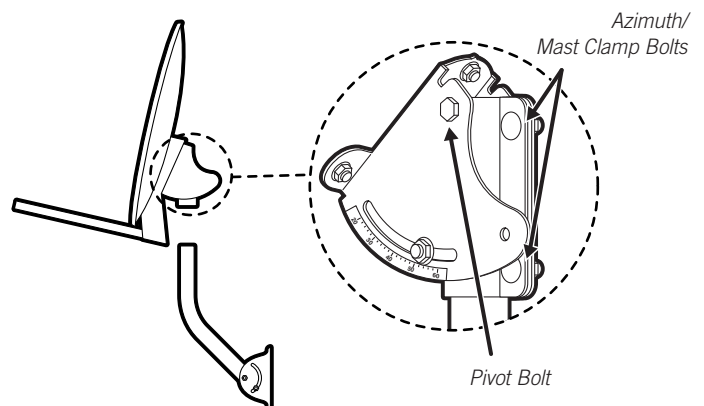

## STEP 6 Routing RG 6 Cable(s)

You'll route RG 6 cable from your receiver to the cable grounding block, then from the grounding block to the triple-head LNB. Before starting, inspect the inside of each cable connector for foreign materials and/or short. Make sure that the copper center conductor is straight and centered in the connector.

### Run cable from receiver

Verify that there are no wires or pipes blocking the location where you want to feed the coaxial cables into your home. Drill a 1/2" inch hole for each cable. Connect cable to the "Sat In" jack on the back of your receiver. To prevent short, leave receiver **unplugged** until Step 9.

### Connect to grounding block

Mount the grounding block close to the point of cable entry into the house. Connect cable to grounding block as shown.

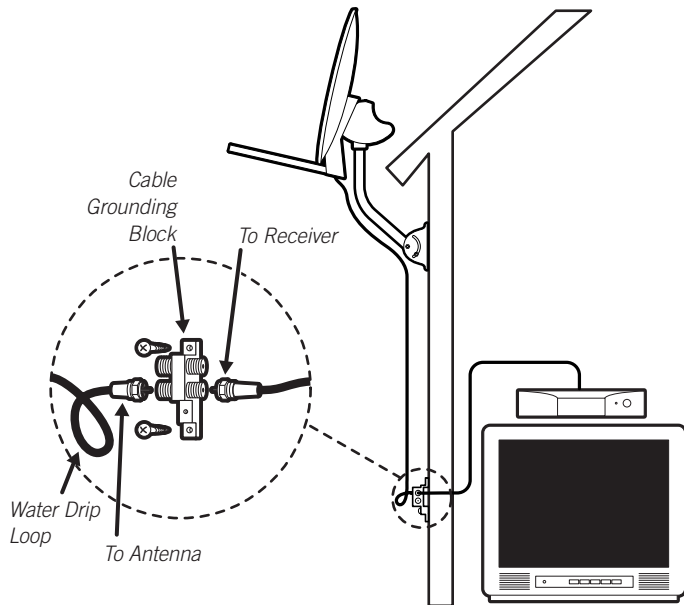

Dual grounding block, one receiver hook up shown

## STEP 7 Grounding Cable and Antenna

Grounding the antenna and cable grounding block help protect the satellite receiver system and other components from lightning damage.

- Ground wire can be attached anywhere on the metal part of the antenna, but there is a convenient grounding screw at one side of the mast base. *Installation should comply with local codes and the National Electric Code (NEC, Sections 250 and 810).*
- Grounding point can be outside metal cold water pipe at point of entry (**no** gas or hot water pipes), 8-foot ground rod, grounded metallic service raceway, grounded electric service equip enclosure, etc. **Option #1:** Both ground wires go to the same ground point. If the two grounding points are different, a #6 copper wire should be connected between them. **Option #2:** The dish antenna grounding wire goes to grounding block first, then to the grounding point.

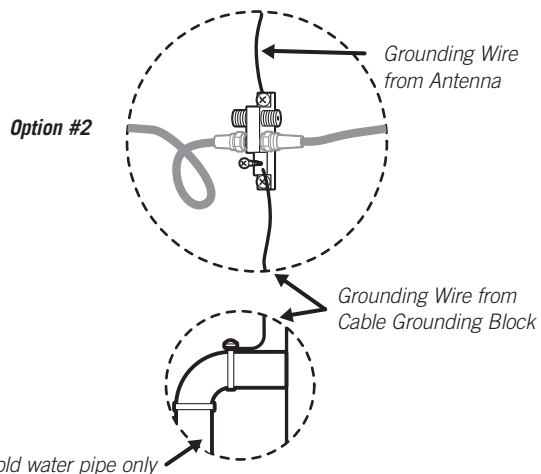
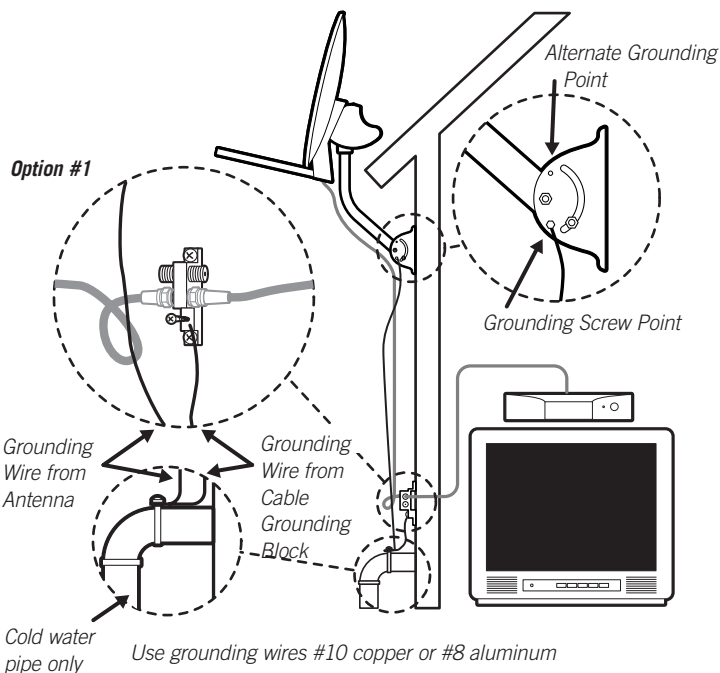



## STEP 8 Attaching LNB to Antenna

The triple-head LNB has four identical outputs, each supporting one independently operating receiver. To simplify future installation of additional receiver(s), you may want to route more cables to the antenna at this point. Only one cable is needed for antenna fine-tuning and alignment.

- RG 6 cable from the grounding block can now be routed to the LNB on your antenna. Attach the triple-head LNB onto the LNB Arm and fasten with included mounting hardware (Phillip screws and nuts). Dress cable with enclosed tie wraps, allowing for cable water drip loop if necessary.

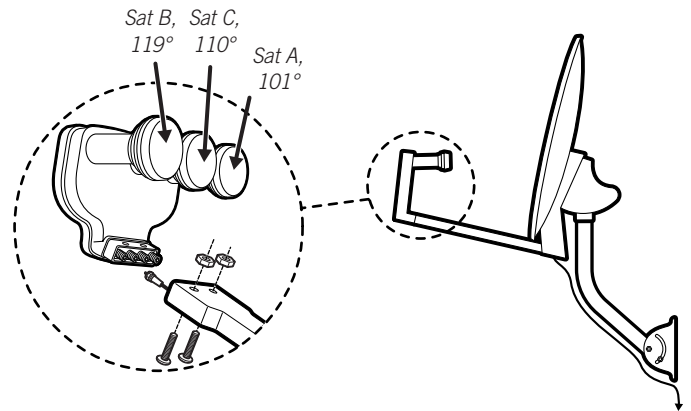

Hooking up cables (one shown) to the LNB and attaching the LNB to Antenna — up to four cables can be connected this way.

## STEP 9 Aiming and Fine-tuning Antenna

When you fine-tune the antenna to one satellite, the other two satellites should be aligned automatically. **Plug in** and turn on your receiver.

- Use the on-screen signal strength meter to fine-tune the antenna. It is important to obtain the strongest signal possible; the higher the signal strength, the less likely you are to experience signal outages during adverse weather.
- With a cell phone and house phone, ask someone to relay signal strength values to you, or hook-up a portable TV at the installation site. Your receiver may be equipped with an audible beep tone feature; the higher pitch, the higher the signal. A hand-held signal meter is also an option.

### Align the Azimuth

- Set your on-screen menu to the signal meter mode, on Satellite A (101°). Use a transponder that is unique to Sat A (such as 1 - 6, 16) for your alignment. Point the antenna to a generally southerly direction, or use the Azimuth number obtained in Step 1 and a compass for a more precise starting point.
- Very slowly rotating the antenna around the mast a few degrees at a time, pause 3 - 5 seconds in between for signal strength meter update. You should be able to find the satellite signal first and then the signal peak, indicated on your screen. Once you sweep through the peak-signal point on the screen, stop. You may want to swing past the peak point a couple of times to make sure.
- Mark the mast and antenna bracket point with a pencil.

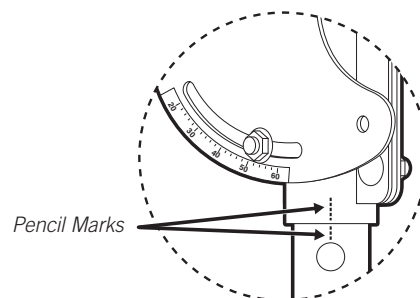
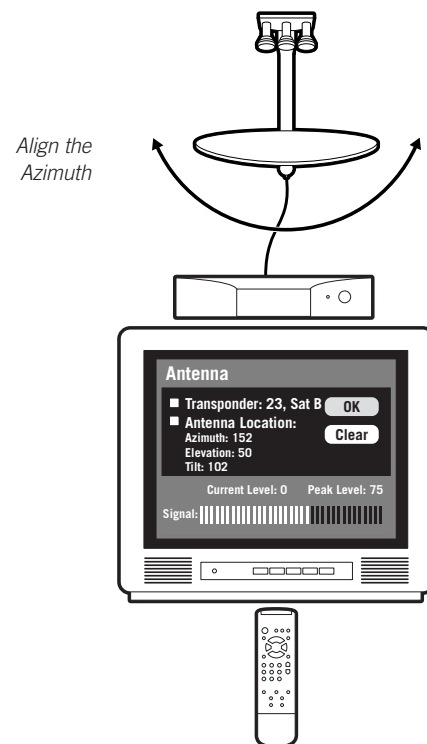

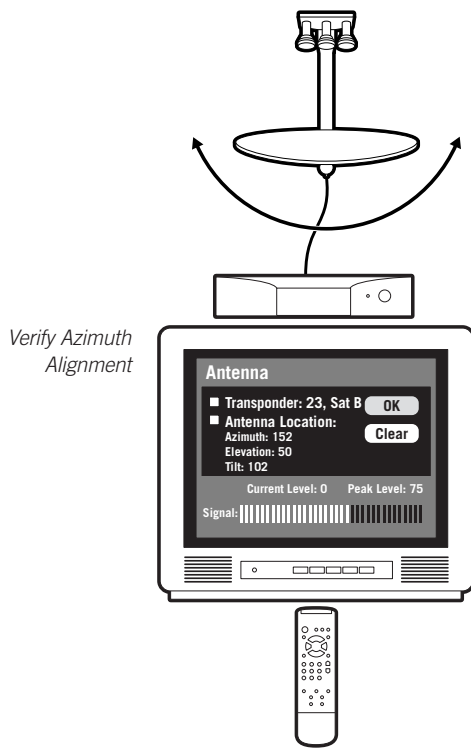

Verify Azimuth Alignment

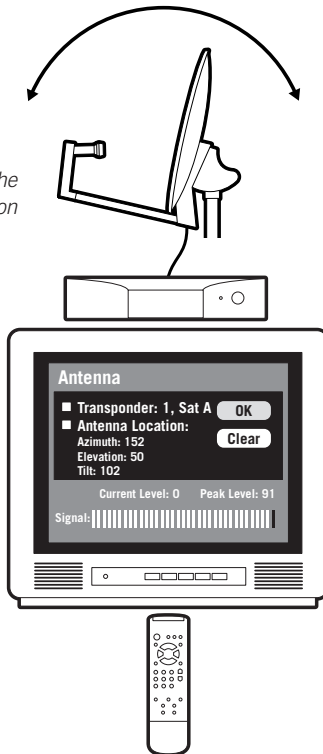

Fine-tune the Elevation

### Verify Azimuth alignment

Switch to Sat B (119°) on your on-screen menu, using Transponders 23, 25, 29 or 31. Verify that signal is also peaked at 119° by very slightly rotating the antenna around the penciled marking on the mast. Once satisfied, tighten the two Azimuth/Mast clamp bolts.

**NOTE:** Sat B (119°) signal strength may read different than Sat A (101°) signal strength, depending on the satellite transmission patterns in the area. You only need to see whether Sat B (119°) is peaked and not try to compare signal strength numbers. It's OK to be close but not at the peaks for both locations simultaneously.

### Fine-tune the Elevation

Use Sat B (119°) or Sat A (101°) on-screen signal meter. While holding the LNB Arm, slightly loosen the two Elevation nuts. Move it up/down slightly and observe the signal strength on the screen. Find the peak and tighten the two Elevation nuts.

### Verify satellite signals

Confirm the final signal-peak readings at all three satellite locations. Sat C (110°, Transponders 8, 10 and 12.) should be aligned automatically.

**NOTE 1:** Occasionally, you may see a transponder at Sat A (101°), Sat B (119°) or Sat C (110°) not active, it is possible that this transponder is reserved for upcoming programming expansion. Switch to other transponders at the same satellite location to verify that you have good readings and that your antenna alignment is satisfactory.

**NOTE 2:** In most of the U.S., the Tilt Adjustment should be fixed. However, because of large Tilt angle to 119° satellite in Eastern Seaboard states, a small amount of Tilt fine-tuning adjustment may improve 119° signal strength without significantly changing 101° signal reading. For these states, the following Tilt fine-tuning procedures are recommended:

1. Follow alignment procedures from Step 1 through Step 9; tighten Elevation and Mast clamp bolts.
2. Fine-tune Tilt Adjustment first by +3 degrees and then -3 degrees. Tilt is optimized when you see the 101° signal reading essentially unchanged and 119° signal strength improved by several points. Set Tilt to the optimized point and tighten Tilt nuts.

# Troubleshooting Check List for Initial Installation

---

If the signal is not found, be sure the receiver user manual and the antenna installation manual have been properly followed. Check to:

- Make sure all cable connections are correct and each connection is seated/tightened properly.
- Inspect the inside of each cable connector for dirt or possible connector to case/shield short.
- Verify the Azimuth, Elevation and Tilt angles for your location by ZIP code.
- Make sure the Tilt and Elevation pointers are aligned correctly to the scales. Do not use washer or bolt as reference.
- Make sure the Tilt adjustment is *not changed* from the recommended setting for the antenna location.
- Make sure the bubble level frame inside the mast is seated properly, then check the mast alignment again. *The mast not being plumb/up straight is a major cause of alignment difficulty.*
- Remove existing TV-specific components, such as TV splitter, etc; reduce the installation to the basic connections called out in this guide. Such components may not work with the satellite signal and they may be in the wall where you can't see them. When in doubt, run RG 6 cable directly to your receiver.
- Make sure there are no obstructions (trees, buildings, windows, corner or overhang of your roof, your body or hands) — the signal does not pass leaves, branches, glass, etc. Also, keep in mind the 18° span clearance to receive all three satellite locations. This required clearance may also mean you'll need to consider a new location when replacing an old 18" dish with this new Multi-Satellite Dish Antenna.
- Make sure the Access Card from your receiver is fully inserted into the Access Card slot and oriented correctly.
- Your triple-head LNB depends on the receiver to supply power; the longer the cable length to the LNB, the greater the DC voltage drop. Your receiver depends on the antenna to supply signal; the longer the cable length, the greater the signal amplitude attenuation. Therefore, RG 6 cable length much longer than 100 feet (from each the receiver to the antenna) should be avoided.
- RG 6 cable with solid copper center conductor is highly recommended because it has much lower DC voltage drop compared to RG 6 cable with a copper-coated, steel center conductor.
- Standard RG 59 cable causes too much DC drop and signal drop; it can not be used to pass the satellite signal. RG 6 coaxial cable must be used.
- Some after-market, off-the-shelf add-on components may not be as advertised. They might not work or could cause additional DC drops and signal amplitude attenuation. Remove such components, go back to the basic connections called out in this manual and re-verify.
- Make sure the satellite cable is connected to the "Sat In" jack, not the "Antenna In" jack. The "Antenna In" jack at the back of the receiver is for off-air antenna input or cable TV input.
- In you live in a state on the Eastern Seaboard, you may need to fine-tune your Tilt Adjustment. Follow directions from NOTE 2, page 10.
- If all are done correctly but the signal is still not found, change the Elevation adjustment of the antenna slightly ( $\pm 2^\circ$ , then  $\pm 4^\circ$  from the called-for setting) and repeat the procedure.

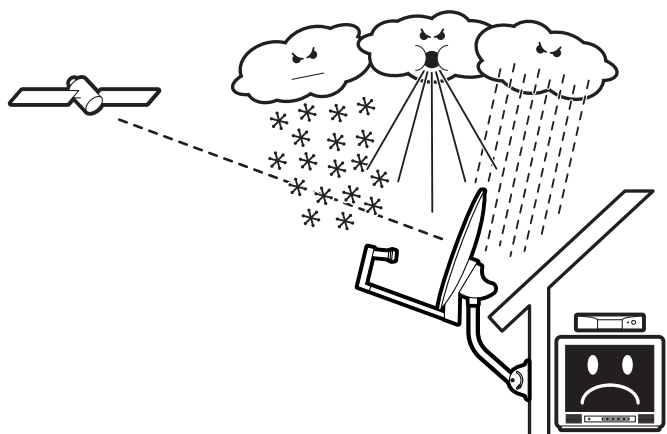

## Loss of Signal/Rain Fade

---

- The satellite signal may be lost temporarily due to unusually heavy rainfall. An optimally aligned antenna, along with the shortest possible cable run, minimizes the chances of “rain fade.”
- Make sure the antenna is mounted securely to prevent it from being blown out of alignment in a heavy wind.
- Heavy snow accumulation on the LNB and the antenna may reduce the satellite signal strength; snow should be swept away as soon as possible.
- Tree foliage growth into antenna’s line-of-sight to the satellite may result in gradual loss of picture.

## Installation with Long Cable Run

---

- For installations where the RG 6 cable runs from the receiver(s) to the LNB far exceeds 100 feet (150 feet or more), as encountered in a commercial or multi-dwelling building, you need to use an AC power booster module to bias the LNB.
- You will also need an additional RF signal amplifier to compensate the signal amplitude loss. Otherwise, your antenna and receiver may not work properly and be subject to frequent outages in adverse weather. Contact a professional concerning such installations.